

PlantVision

OPD V5.0.2

Operator Dialog for PCS 7

Manual

Preface, Contents

Requirements for Getting Started

Overview of OPD

Installation

Configuration

User permissions

Licensing

Appendix

1

2

3

4

5

6

7

Preface

Purpose of the Manual

OPD manual provides you with a detailed description of the OPD functionality and helps you to install and configure the OPD with your PCS 7 project.

Required Experience

You should have experience in the following areas:

- Microsoft operating system Windows (7, 10, 2008, 2012)
- Functions and configuration of SIMATIC PCS 7 (STEP 7, WinCC)

Further Support

If you have any technical questions, please get in touch with OPD support

support@pcs7opd.com

Contents

1. REQUIREMENTS FOR GETTING STARTED	5
1.1. REQUIRED HARDWARE	5
1.2. REQUIRED SOFTWARE	5
2. OVERVIEW OF OPD	6
2.1. WHERE TO USE THE OPD	6
2.2. MAIN FEATURES	6
2.3. OPD DIALOG (OPDGUI)	8
2.3.1. <i>Process values</i>	9
2.3.2. <i>Operator comment</i>	9
2.3.3. <i>Operator values</i>	9
2.3.4. <i>Option boxes</i>	10
2.3.5. <i>Check boxes</i>	10
2.3.6. <i>Electronic signatures</i>	11
2.3.7. <i>Entry requirement</i>	11
2.3.8. <i>Bridge values</i>	12
2.4. OPD ICON	13
2.5. OPD S7 BLOCK	14
2.6. WATCHDOG TIMER	16
2.7. HMI TIMER	16
2.8. AUDIT TRAIL	16
3. INSTALLATION	17
3.1. INSTALLATION MODULES	17
3.2. INSTALLATION SCENARIOS	17
3.2.1. <i>Single station setup</i>	17
3.2.2. <i>Server-client setup</i>	17
3.2.3. <i>Webnavigator setup</i>	18
3.3. INSTALLATION PROCEDURE	18
3.3.1. <i>OPD setup.msi</i>	18
3.3.2. <i>Configuration file</i>	19
3.3.3. <i>Language file</i>	19
3.3.4. <i>S7 function block</i>	19
3.3.5. <i>Server graphics</i>	19
3.3.6. <i>Client graphics</i>	19
3.3.7. <i>Scripts</i>	21
3.3.8. <i>Actions</i>	22
3.3.9. <i>Server tags</i>	23
3.3.10. <i>Client tags</i>	23
3.3.11. <i>WinCC messages</i>	23
3.3.12. <i>Standard Server configuration</i>	24
4. CONFIGURATION	25
4.1. LANGUAGE FILE	25
4.2. CONFIGURATION FILE	25
5. USER PERMISSION	29
6. LICENSING	30
6.1. WEB SERVER LICENSE	30

7.	APPENDIX	31
7.1.	OPD BLOCK INPUTS/OUTPUTS	31
7.2.	OS SERVER TAGS.....	36
7.3.	OS CLIENT TAGS.....	37
7.4.	WINCC MESSAGES.....	38
7.5.	SCRIPTS	40
7.6.	ACTIONS.....	41

1. Requirements for getting started

1.1. Required Hardware

The OPD hardware requirements are the same as for PCS 7 V8.1, V8.2 and V9.0.

1.2. Required Software

PCS 7: V8.1, V8.2, V9.0

Operating System: same as for PCS 7 (see versions above)

2. Overview of OPD

The Operator Dialog, OPD software is designed to simplify the interactions between operators and automated control systems. It does not only provide the operator with a powerful tool to make the control of the process easier, but it also gives a complete trace of operator's manual operations – a must in a validated batch system.

The OPD is based on SIMATIC PCS 7. Through the integration with SIMATIC Logon for user verification and electronic signatures, the OPD meets the requirements coming from 21 CFR part 11, and other regulatory requirements. The OPD resembles the PCS 7 APL library both in design and functionality, which makes it easy to adapt to any PCS 7 projects.

2.1. Where to use the OPD

Operator Interaction during SFC phase

An OPD can be applied during an SFC phase. The simplest operator interaction could be to ask the operator to acknowledge an OPD message before entering the next step of the phase. Another example is to ask the operator to select between two storage tanks. Each one of the cases above can also require one or several electronic signatures.

Operator Interaction between two SFC phases

An OPD can also be applied for operator interactions on the batch level, between two separate SFC phases. The operator could be asked to choose between different equipment, which require separate unit allocations.

Operator Interaction for event-based actions

An OPD can be used for event-based actions. The operator could be asked to acknowledge an OPD message before opening a valve or changing the parameters on a PID loop.

2.2. Main features

Flexible design of the operator dialogs

Each OPD message can be configured with:

- 1 text message (1020 characters)
- 1 operator comment (1020 characters)
- 1..10 process values (string or real)
- 1..10 operator values (string or real)
- 1 Option Group with up to 10 Option Boxes
- 1 Check Group with up to 10 Check Boxes
- 1..2 Electronic Signatures

Electronic signatures

The OPD has a built-in option for handling of Electronic signatures. The signatures are stored in form of WinCC Event Messages. The benefit of this is that they are automatically included in the standard SIMATIC Batch Report and could be also transferred to any MES system that handles long time archiving of PCS7 process data.

APL design

The OPD resembles the APL library in both design and functionality.

Webnavigator

The OPD is compatible with WinCC Webnavigator. The OPD can be used both on standard thick OS clients as well as on the thin clients.

Multilanguage support

The OPD uses language libraries and all texts used by OPD can be translated to any language.

Redundant Servers

The OPD supports redundant OS servers an several server pairs.

Multiclient protection

The OPD cannot be opened at several clients simultaneously. Once the OPD is opened, it gets occupied by the client and it is not possible to open it from any other station. If any operator tries to do so, he/she will be prompted with the name of the client that "occupies" the OPD and for how long the OPD is occupied.

The operator has a certain, preconfigured time to enter the operator values and either close or execute the OPD. If the timer expires, the OPD will be disabled and released.

2.3. OPD dialog (OPDGUI)

OPDGUI is the operator interface for viewing of the OPD messages. The graphical appearance of the OPDGUI is dependent on the message configuration and varies for each message. The following information is always included on the OPDGUI:

- Equipment Name (Tag name)
- Batch Name
- OPD message number
- OPD message text (1020 characters)
- Remaining time for the execution of the OPD message
- Execute Button.

The remaining information is configurable.

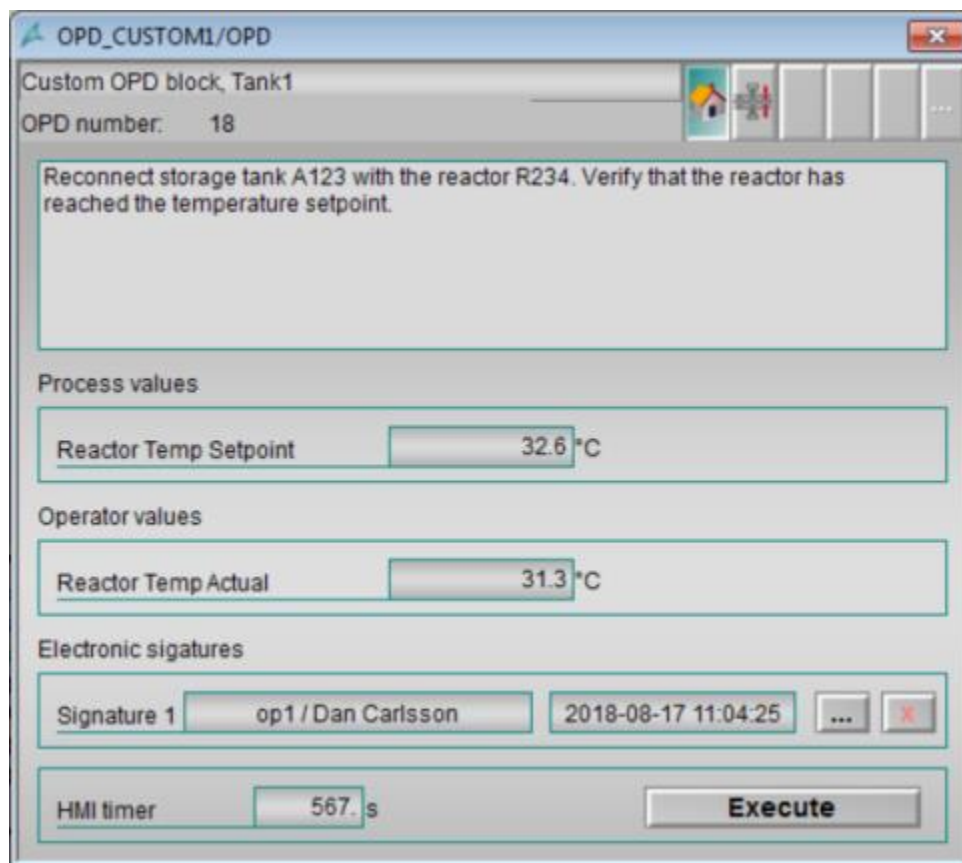

2.3.1. Process values

In addition to OPD message text, it is possible to connect up to 10 real or string (32 char) process values to the OPD S7 block and view them for the operator. The inputs on the block are PVx_R (real) and PVx_S (string). The values are saved as WinCC event messages (Audit Trail).

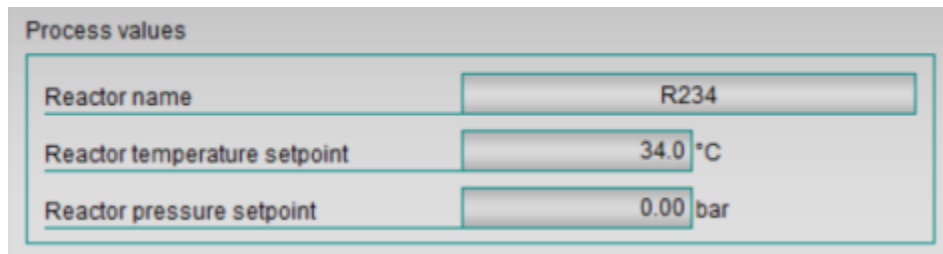

Process values	
Reactor name	R234
Reactor temperature setpoint	34.0 °C
Reactor pressure setpoint	0.00 bar

2.3.2. Operator comment

The operator can write a comment (1020 characters). The comment is not written down to the S7 block but it is saved as a WinCC event message (Audit Trail).



Comment
The piping between reactor R234 and storage tank R234 is leaking.

2.3.3. Operator values

The operator can enter up to 10 operator values (real or string (32 char)). The values are written down to the S7 block and can be used further in the process. The outputs on the block are QOPVx_R (real) and QOPVx_S (string). The values are also saved as WinCC event messages (Audit Trail). The entry of real values is limited by a high and low limit: OPVx_L1 and OPVx_H1 on the S7 block.

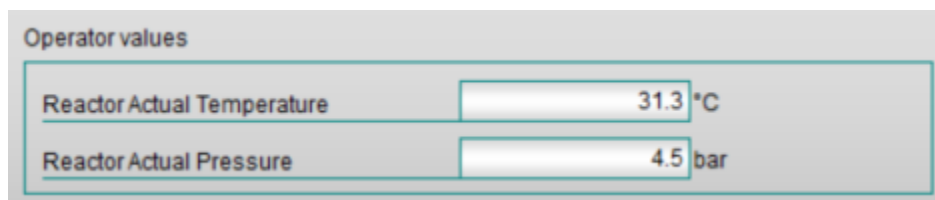

Operator values	
Reactor Actual Temperature	31.3 °C
Reactor Actual Pressure	4.5 bar

2.3.4. Option boxes

The operator can select from up to 10 option boxes. The selection is written down to the S7 block and can be used further in the process.

The output on the block is QOPOSEL1 (1=Option 1, 2=Option 2, 4=Option 3, 8=Option 4, 16=Option 5, 32=Option 6, 64=Option 7, 128=Option 8, 256=Option 9, 512=Option 10,).

The selection is also saved as a WinCC event message (Audit Trail).



2.3.5. Check boxes

The operator can select/check up to 10 check boxes. The selection is written down to the S7 block and can be used further in the process.

The output on the block is QOPCSEL1 (Binary output: 1=check 1, 11= check 1 and 2, 101=check1 and check 3 ...).

The selection is also saved as a WinCC event message (Audit Trail).



2.3.6. Electronic signatures

The OPD GUI can contain 0-2 electronic signatures. Each signature can be assigned to one or several User Groups. Both signatures cannot be performed by the same user. All signatures must be performed before the OPD can be executed/acknowledged. The signatures are written down to the S7 block and can be used further in the process. The signatures are also saved as WinCC event messages (Audit Trail).

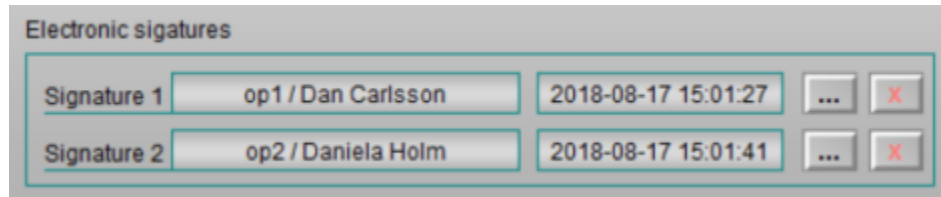

2.3.7. Entry requirement

For each operator input, it is possible to set an entry requirement individually. The operator must enter or select a value before signing of or executing/acknowledging the OPD. This is valid for operator values, option boxes, check boxes and operator comment. Additionally, for check boxes, there is an option to require all check boxes to be selected before signing of or executing/acknowledging the OPD.



2.3.8. Bridge values

It is possible to automatically copy the values from Process Values to Operator Values. This is done by activating the Bridge Values property. This function can be useful when OPD is required to change alarm limits or any other analog values.

The screenshot displays the 'OPD_CUSTOM1/OPD' window. At the top, it shows 'Custom OPD block, Tank1' and 'OPD number: 15'. Below this is a large text area with the prompt 'Enter the new alarm limit.' The 'Process values' section contains a field for 'Old alarm limit' with a value of '13.45 kg'. The 'Operator values' section contains a field for 'New alarm limit' with a value of '13.45 kg'. The 'Electronic signatures' section includes a 'Signature 1' field with a slash '/' and a button with a checkmark. At the bottom, there is an 'HMI timer' field showing '577. s' and an 'Execute' button.

2.4. OPD icon

The OPD icon is used for opening of the OPD dialog. The icon is located on *@PCS7TypicalsOPD.pdl*. During OS compile, the icons are created automatically on OS graphics for each OPD S7-block instance. Icon changes color depending on the OPD state. If the OPD instance is already opened on any OS client in the system, the icon turns green and it is impossible to click on it.

Icon color	State
 Grey	OPD inactive
 Magenta	OPD active
 Green	OPD active and opened

There are two types of OPD icon:

1. Default: Type 1
2. Self-opening: Type 2

The self-opening type will open the OPD GUI automatically when the OPD is enabled.

2.5. OPD S7 block

The OPD S7-block is the interface between the OPDGUI and the process. It is recommended to have several instances of the OPD block in one S7-program. The recommendation is to use one block per Equipment Module/Sequence or Control Module, depending on your process model. Only one OPD message can be activated/enabled simultaneously on one S7-block.

It is recommended to use the *Block contacts* feature on the SFC type when connecting the OPD block with the SFC type.

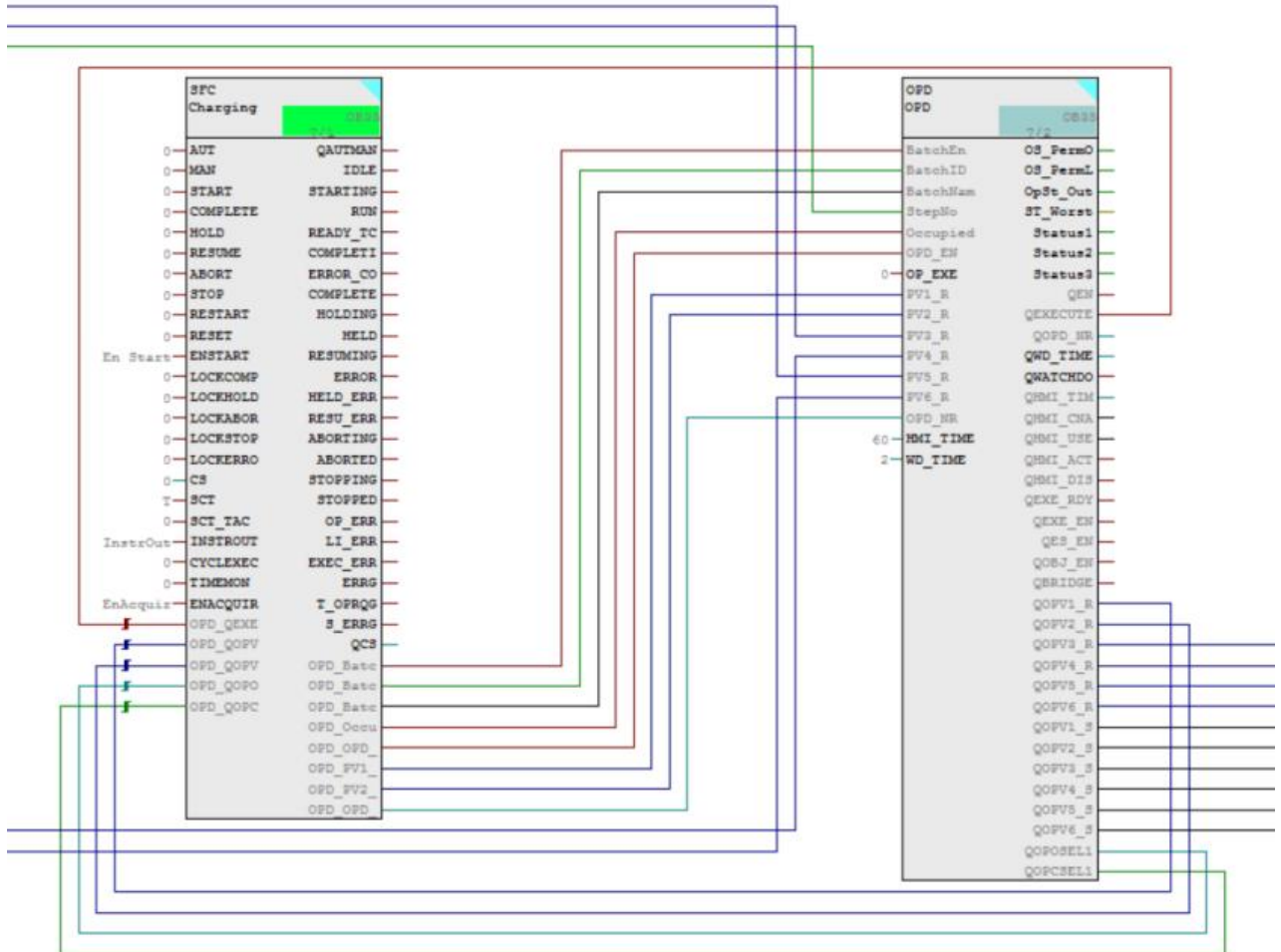

In order to activate/enable the OPD S7-block, set the "OPD_NR" input with the desired OPD dialog number and set the "OPD_EN" to true. The OPD block will trigger an Operator Request message in WinCC notifying the operator about the activated OPD. The OPD icon turns magenta. Once the OPD is executed, the "QEXECUTE" output will be set to true and the "OPD_EN" must be reset manually.

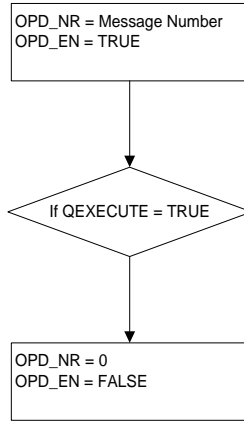

Set the OPD message number and enable the block.

If OPD is acknowledged

Reset the message number and disable the block.

When two subsequent OPDs are used in an SFC, make sure to add an extra step between that disables the S7-block.

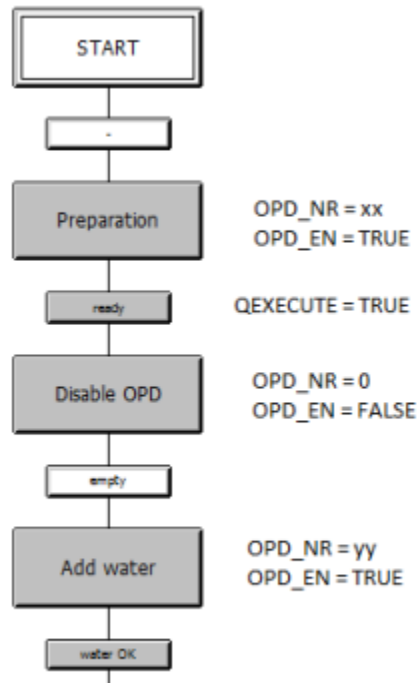

It is possible to disable the OPD automatically after the “Execute” – button is pressed. This is done by enabling the *SelfDisable* property on the S7-block.

S7 block inputs and outputs are described in chapter 7.1.

2.6. Watchdog timer

The watchdog timer makes sure that the communication between the S7-block and the OPD dialog is working correctly. If the communication is broken, the watchdog timer will time out and disable the OPD block.

The timer is set by default to 2 seconds (block input *WD_TIME*). When using Web Navigator, it might be necessary to increase it.

2.7. HMI timer

The HMI timer makes sure that the OPD dialog is not open on an OS client for too long. If the timer times out the OPD dialog is disabled and can be opened on a different OS client. The HMI timer is set by default to 300 seconds.

2.8. Audit Trail

All the data (viewed and entered) on the OPD dialog is saved as WinCC Messages in the WinCC database. The OPD Audit Trail messages must be pre-configured in the Alarm Logging application in WinCC. The WinCC message configuration is specified in section 0.

17-08-18	10:59:46.000	0	OPD_CUSTOM1/OPD	***** OPD ES BEGIN *****
17-08-18	10:59:46.001	0	OPD_CUSTOM1/OPD	OPD Message Nr: 18 executed by op1
17-08-18	10:59:46.010	0	OPD_CUSTOM1/OPD	OPD Message Part 1: Reconnect storage tank A123 with the reactor R234. Verify that th
17-08-18	10:59:46.020	0	OPD_CUSTOM1/OPD	OPD Process Value 1 Reactor Temp Setpoint: 32.6 °C
17-08-18	10:59:46.030	0	OPD_CUSTOM1/OPD	OPD Operator Value 1 Reactor Temp Actual: 31.3 °C
17-08-18	10:59:46.070	0	OPD_CUSTOM1/OPD	OPD Electronic Signature 1 op1/op1 on 2018-08-17 10:53:26
17-08-18	10:59:46.100	0	OPD_CUSTOM1/OPD	***** OPD ES END *****

3. Installation

3.1. Installation modules

OPD consists of the following modules:

1. Configuration file (OPDconfig.csv)
2. Language file (OPDlanguage.csv)
3. S7 function block (OPD FB)
4. Server graphics (.pdl)
5. Client graphics (.pdl)
6. Scripts (C-scripts, VB-scripts)
7. Actions (VB-actions)
8. Server tags
9. Client tags
10. WinCC Messages

3.2. Installation scenarios

3.2.1. Single station setup

The following modules should be installed on the single station:

1. Configuration file (OPDconfig.csv)
2. Language file (OPDlanguage.csv)
3. S7 function block (OPD FB)
4. Server graphics (.pdl)
5. Client graphics (.pdl)
6. Scripts (C-scripts, VB-scripts)
7. Actions (VB-actions)
8. Server tags
9. Client tags
10. WinCC Messages

3.2.2. Server-client setup

AS project

The following modules should be installed/configured on the AS project:

1. S7 function block (OPD FB)

OS server project

The following modules should be installed/configured on the OS server project:

1. Server tags
2. WinCC Messages
3. Server graphics (.pdl)
4. Actions (VB-actions)
5. Scripts (C-scripts, VB-scripts)

OS client project

The following modules should be installed/configured on the OS client project:

1. Client graphics (.pdl)
2. Scripts (C-scripts, VB-scripts)
3. Client tags
4. Standard Server for Alarms should be set to preferred OS server.

OS client(s)

The following modules should be installed/configured on the OS client(s):

1. Configuration file (OPDconfig.csv)
2. Language file (OPDlanguage.csv)

3.2.3. Webnavigator setup

AS project

The following modules should be installed/configured on the AS project:

1. S7 function block (OPD FB)

OS server project

The following modules should be installed/configured on the OS server project:

1. Server tags
2. WinCC Messages
3. Server graphics (.pdl)
4. Actions (VB-actions)
5. Scripts (C-scripts, VB-scripts)

OS client project

The following modules should be installed/configured on the OS client project:

1. Client graphics (.pdl)
2. Scripts (C-scripts, VB-scripts)
3. Client tags
4. Standard Server for Alarms should be set to preferred OS server.

Webnavigator client(s)

The following modules should be installed/configured on the Webnavigator client(s):

1. Configuration file (OPDconfig.csv)
2. Language file (OPDlanguage.csv)

3.3. Installation procedure

3.3.1. OPD setup.msi

Run the installation file: OPD setup.msi. Follow the installation procedure. The setup installs the following folders under the installation folder (default installation folder: C:\\Program File (x86)\\OPD):

- Installation package, contains all the necessary configuration files.
- Manual, contains the manual
- Release notes, contains the release notes

3.3.2. Configuration file

The configuration file is placed automatically by the OPD setup in the default folder:
C:\ProgramData\OPD\OPDconfig.csv.

The file can be placed manually in any folder on the OS client station or the Webnavigator client. If the folder path is changed from default, make sure to change the starting value of the OS client TAG: *OPD_CSV_PATH.*

(The folder *C:\ProgramData* can be found by either manually entering the name in the File Explorer or by enabling the “*Show hidden files and folders*” under *Tools->Folder Options->View*)

3.3.3. Language file

The language file is placed automatically by the OPD setup in the default folder:
C:\ProgramData\OPD\OPDlanguage.csv.

The file can be placed manually in any folder on the OS client station or the Webnavigator client. If the folder path is changed from default, make sure to change the starting value of the OS client TAG: *OPD_LANGUAGE_PATH.*

(The folder *C:\ProgramData* can be found by either manually entering the name in the File Explorer or by enabling the “*Show hidden files and folders*” under *Tools->Folder Options->View*)

3.3.4. S7 function block

- Retrieve the OPD S7 library (OPD_lib.zip) located in the installation package folder.
- Copy the following blocks into your project:
 1. FB587, OPD
 2. FB5, TIMER_P
 3. SFB35, ALARM_8P
 4. SFC20, BLKMOV
- Insert the OPD block to a CFC chart and connect the input/outputs as needed.
- The OPD block can be inserted into any number of CFC charts. The recommendation is to have one OPD CFC chart per SFC sequence.
- It is recommended to use the *Block contacts* feature on the SFC type when connecting the OPD block with the SFC type.

3.3.5. Server graphics

Copy the file: *@PCS7TypicalsOPD.pdf* file, located in the installation package folder (server graphics), to the *Gracs*-folder of the OS server (or OS single station) project.

3.3.6. Client graphics

Copy the following files, located in the installation package folder (client graphics):

- *@PG_OPD.pdf*

- @PG_OPD_INFO.pdl
- @PG_OPD_STANDARD.pdl
- @PG_OPD_OVERVIEW.pdl
- @PG_OPD_VIEWTOOLBAR.pdl
- @PG_OPD_OA_ANALOG.pdl
- @PG_OPD_OA_ES.pdl
- @PG_OPD_OA_STRING.pdl
- @PG_OPD_OA_EXECUTE.pdl

to the *Gracs*-folder of the OS client (OS single station) project.

3.3.7. Scripts

Copy the entire folder (*OPD*) containing the c-script files (*OPD... .fct*), located in the installation package folder (*Scripts/C-scripts*), to the *Library*-folder of the OS client (or OS single station) project:

`<project directory>\wincproj\<project name>\Library\`

- Open the C-Editor in WinCC.
- Regenerate headers.
- Recompile all functions.

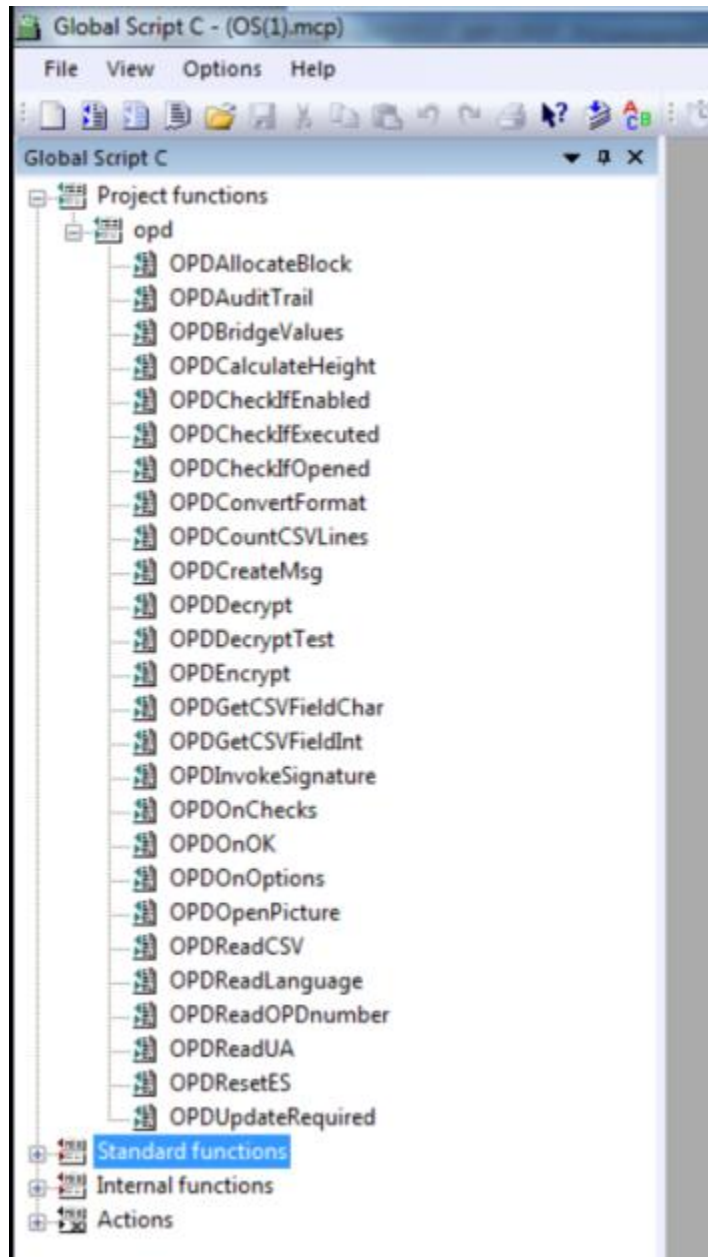

Copy the entire folder (*OPD*) containing all VB-script files (*OPD_....bmo*), located in the installation package folder (*scripts/VB-scripts*), to the *ScriptLib* -folder of the OS client (or OS single station) project:

`<project directory>\wincproj\<project name>\ScriptLib\`

If the folder does not exist, create it manually.

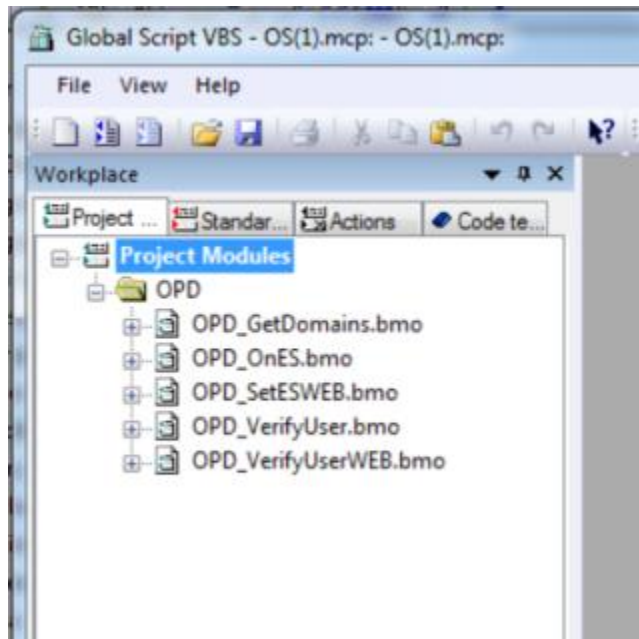

The scripts are listed in chapter 7.5.

3.3.8. Actions

Copy the entire folder (*OPD*) containing all VB-action files (*OPD_... .bac*), to the *ScriptAct* - folder of the OS client (or OS single station) project:

`<project directory>\wincproj\<project name>\ScriptAct\`

If the folder does not exist, create it manually.

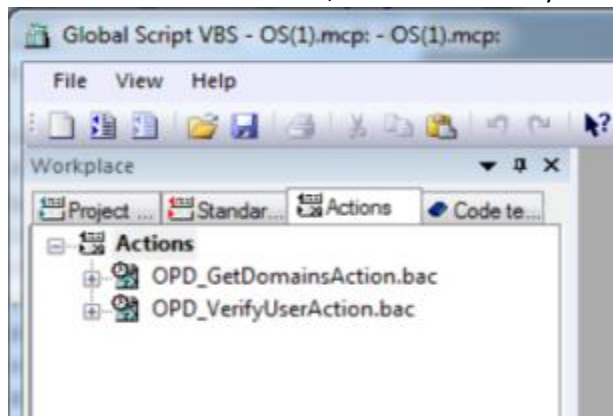

The actions are listed in chapter 7.6.

3.3.9. Server tags

- On the OS server (or OS single station) project, open the WinCC Explorer and Tag Management.
- Make sure the group *OPD* is created under *Internal tags*. If not, create a new group and name it: *OPD*.
- Select Edit→Import
- Select the *OPDServerTags.txt* file, located in the installation package folder (Server tags).

The tags should be configured on the OS server (or OS single station) project according to chapter 7.2.

3.3.10. Client tags

- On the OS client (or OS single station) project, open the WinCC Explorer and Tag Management.
- Make sure the group *OPD* is created under *Internal tags*. If not, create a new group and name it: *OPD*.
- Select Edit→Import
- Select the *OPDClientTags.txt* file, located in the installation package folder (client tags).
- Make sure that the Start value of the *OPD_CSV_PATH* tag and *OPD_LANGUAGE_PATH* is correct.

The tags should be configured on the OS client (or OS single station) project according to chapter 7.3.

3.3.11. WinCC messages

- Open the OS server (or OS single station) project
- Open Alarm Logging
- Import the WinCC messages from the file: *OPDMessages.txt* by selecting *Edit->Import*

The messages should be configured on the OS client (or OS single station) project according to chapter 7.4.

3.3.12. Standard Server configuration

- Open the OS client project
- Open Server data
- Select Standard server for Alarms

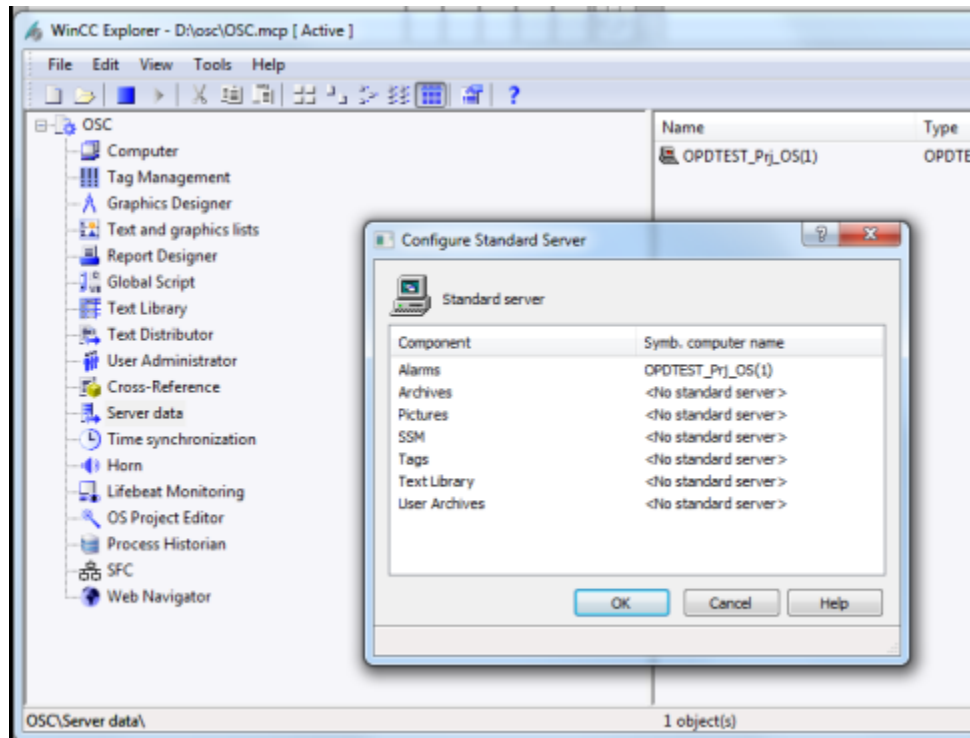

4. Configuration

4.1. Language file

The default location for the language file is `C:\ProgramData\OPD\OPDlanguage.csv`. If the default folder path is changed, make sure to change the starting value of the OS client TAG: `OPD_LANGUAGE_PATH`.

The language file consists of at least two columns: ID and Language 1 string (English by default). Each additional language is represented by another column. The columns are separated by commas. To edit the language file, use a spreadsheet tool or notepad. Either change the existing language or add a new one. Make sure that each row is finished by a comma.

ID	English (language name 1)	Swedish (language name 2)	... (language name 3)
1	OPD number	OPD nummer	...
2	Comment	Kommentar	...
3	Process values	Processvärden	...
4	Process value 1	Processvärde 1	...
...
61

To select a language, make sure that the string tag on the OS client: `OPD_LANGUAGE` corresponds with the name of the language in the top row of the language file.

4.2. Configuration file

The default location of the configuration file is: `C:\ProgramData\OPD\OPDconfig.csv`. If the default folder path is changed, make sure to change the starting value of the OS client TAG: `OPD_CSV_PATH`.

The configuration file consists of several columns, each column represents an OPD property. The columns are separated by commas “,”. Each line represents one OPD message. The line must be terminated by a vertical bar “|”. The vertical bar cannot be used in any OPD property.

The following is the list of all properties in the file:

Property	Description
OPDNumber	OPD dialog number
Message	OPD text message (1020 characters)
BridgeValues	The values connected to Process values are automatically transferred to Operator values (as default)
State	Not used
Version	Not used
CommentActive	Activate comment
CommentRequired	Comment is required and must be entered
PV1Active	Activate Process Value 1 (corresponds with the S7 block input PV1_R and PV1_S)

Property	Description
PV1Label	Process Value Label (32 characters)
PV1Type	Process Value Type (0=analog, 1=string)
PV1Unit	Process Value Unit (10 characters)
PV1Format	Process Value Format (##00.000)
PV2Active	Activate Process Value 2 (corresponds with the S7 block input PV2_R and PV2_S)
PV2Label	Process Value Label (32 characters)
PV2Type	Process Value Type (0=analog, 1=string)
PV2Unit	Process Value Unit (10 characters)
PV2Format	Process Value Format (##00.000)
PV3Active	Activate Process Value 3 (corresponds with the S7 block input PV3_R and PV3_S)
PV3Label	Process Value Label (32 characters)
PV3Type	Process Value Type (0=analog, 1=string)
PV3Unit	Process Value Unit (10 characters)
PV3Format	Process Value Format (##00.000)
PV4Active	Activate Process Value 4 (corresponds with the S7 block input PV4_R and PV4_S)
PV4Label	Process Value Label (32 characters)
PV4Type	Process Value Type (0=analog, 1=string)
PV4Unit	Process Value Unit (10 characters)
PV4Format	Process Value Format (##00.000)
PV5Active	Activate Process Value 5 (corresponds with the S7 block input PV5_R and PV5_S)
PV5Label	Process Value Label (32 characters)
PV5Type	Process Value Type (0=analog, 1=string)
PV5Unit	Process Value Unit (10 characters)
PV5Format	Process Value Format (##00.000)
PV6Active	Activate Process Value 6 (corresponds with the S7 block input PV6_R and PV6_S)
PV6Label	Process Value Label (32 characters)
PV6Type	Process Value Type (0=analog, 1=string)
PV6Unit	Process Value Unit (10 characters)
PV6Format	Process Value Format (##00.000)
OPV1Active	Activate Operator Value 1 (corresponds with the S7 block output QOPV1_R and QOPV1_S)
OPV1Required	Operator Value is required and must be entered
OPV1Label	Operator Value Label (32 characters)
OPV1Type	Operator Value Type (0=analog, 1=string)
OPV1Unit	Operator Value Unit (10 characters)
OPV1Format	Operator Value Format (##00.000)
OPV2Active	Activate Operator Value 2 (corresponds with the S7 block output QOPV2_R and QOPV2_S)
OPV2Required	Operator Value is required and must be entered
OPV2Label	Operator Value Label (32 characters)
OPV2Type	Operator Value Type (0=analog, 1=string)
OPV2Unit	Operator Value Unit (10 characters)
OPV2Format	Operator Value Format (##00.000)

Property	Description
OPV3Active	Activate Operator Value 3 (corresponds with the S7 block output QOPV3_R and QOPV3_S)
OPV3Required	Operator Value is required and must be entered
OPV3Label	Operator Value Label (32 characters)
OPV3Type	Operator Value Type (0=analog, 1=string)
OPV3Unit	Operator Value Unit (10 characters)
OPV3Format	Operator Value Format (##00.000)
OPV4Active	Activate Operator Value 4 (corresponds with the S7 block output QOPV4_R and QOPV4_S)
OPV4Required	Operator Value is required and must be entered
OPV4Label	Operator Value Label (32 characters)
OPV4Type	Operator Value Type (0=analog, 1=string)
OPV4Unit	Operator Value Unit (10 characters)
OPV4Format	Operator Value Format (##00.000)
OPV5Active	Activate Operator Value 5 (corresponds with the S7 block output QOPV5_R and QOPV5_S)
OPV5Required	Operator Value is required and must be entered
OPV5Label	Operator Value Label (32 characters)
OPV5Type	Operator Value Type (0=analog, 1=string)
OPV5Unit	Operator Value Unit (10 characters)
OPV5Format	Operator Value Format (##00.000)
OPV6Active	Activate Operator Value 6 (corresponds with the S7 block output QOPV6_R and QOPV6_S)
OPV6Required	Operator Value is required and must be entered
OPV6Label	Operator Value Label (32 characters)
OPV6Type	Operator Value Type (0=analog, 1=string)
OPV6Unit	Operator Value Unit (10 characters)
OPV6Format	Operator Value Format (##00.000)
OptionGrp1Active	Activate Option Group 1 (corresponds with the S7 block output QOPOSEL1)
OptionGrp1Required	Option Group is required and must be selected
OptionGrp1Label	Option Group Label (32 characters)
OptionGrp1_Option1	Option 1 Label (32 characters)
OptionGrp1_Option2	Option 2 Label (32 characters)
OptionGrp1_Option3	Option 3 Label (32 characters)
OptionGrp1_Option4	Option 4 Label (32 characters)
OptionGrp1_Option5	Option 5 Label (32 characters)
OptionGrp1_Option6	Option 6 Label (32 characters)
OptionGrp1_Option7	Option 7 Label (32 characters)
OptionGrp1_Option8	Option 8 Label (32 characters)
OptionGrp1_Option9	Option 9 Label (32 characters)
OptionGrp1_Option10	Option 10 Label (32 characters)
CheckGrp1Active	Activate Check Group 1 (corresponds with the S7 block output QOPCSEL1)
CheckGrp1Required	Check Group is required and must be selected

Property	Description
CheckGrp1AllRequired	All "checks" must be selected
CheckGrp1Label	Check Group Label (32 characters)
CheckGrp1_Check1	Check 1 Label (32 characters)
CheckGrp1_Check2	Check 2 Label (32 characters)
CheckGrp1_Check3	Check 3 Label (32 characters)
CheckGrp1_Check4	Check 4 Label (32 characters)
CheckGrp1_Check5	Check 5 Label (32 characters)
CheckGrp1_Check6	Check 6 Label (32 characters)
CheckGrp1_Check7	Check 7 Label (32 characters)
CheckGrp1_Check8	Check 8 Label (32 characters)
CheckGrp1_Check9	Check 9 Label (32 characters)
CheckGrp1_Check10	Check 10 Label (32 characters)
ES1Active	Activate Electronic Signature 1 (corresponds with the S7 block output QES1_UNAME (user name), QES1_FNAME (full name), QES1_DATE (date time), QES1_CNAME (computer name))
ES1RequiredGroups	Required user groups. Each group ends with #, OperatorsABC#Administrators# (255 characters)
ES2Active	Activate Electronic Signature 2 (corresponds with the S7 block output QES2_UNAME (user name), QES2_FNAME (full name), QES2_DATE (date time), QES2_CNAME (computer name))
ES2RequiredGroups	Required user groups. Each group ends with #, OperatorsABC#Administrators# (255 characters)

5. User permission

The permission to operate the OPD is set on the icon, property: *OperationLevel1*. By default, the permission is set to standard PCS7 authorization level 5: Process Controlling.

(The *properties: OperationLevel2 and OperationLevel3* are not used by OPD).

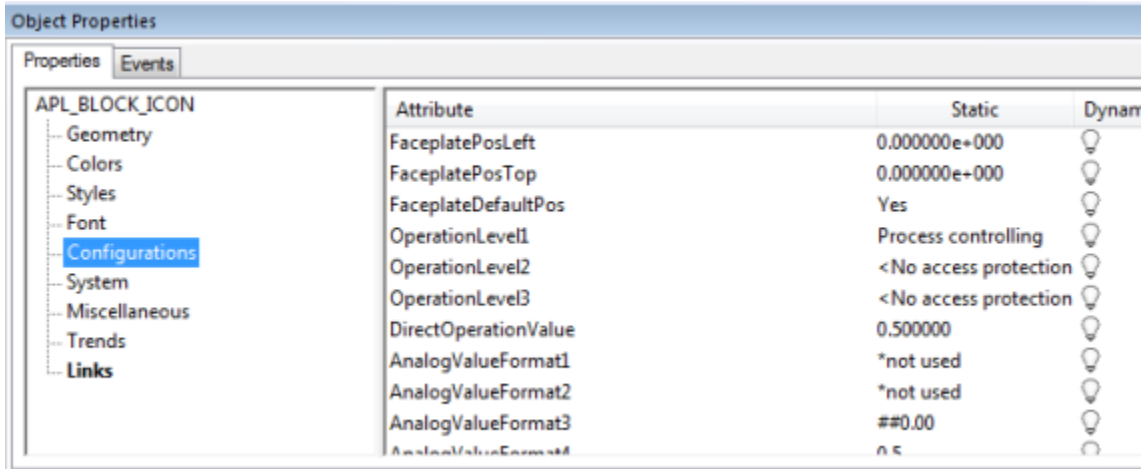

The screenshot shows the 'Object Properties' dialog box for the object 'APL_BLOCK_ICON'. The 'Configurations' tab is selected, displaying a table of attributes and their values. The 'OperationLevel1' attribute is set to 'Process controlling', while 'OperationLevel2' and 'OperationLevel3' are set to '<No access protection'. Other attributes include 'FaceplatePosLeft', 'FaceplatePosTop', 'FaceplateDefaultPos', 'DirectOperationValue', and three 'AnalogValueFormat' attributes.

Attribute	Static	Dynam
FaceplatePosLeft	0.000000e+000	⚡
FaceplatePosTop	0.000000e+000	⚡
FaceplateDefaultPos	Yes	⚡
OperationLevel1	Process controlling	⚡
OperationLevel2	<No access protection	⚡
OperationLevel3	<No access protection	⚡
DirectOperationValue	0.500000	⚡
AnalogValueFormat1	*not used	⚡
AnalogValueFormat2	*not used	⚡
AnalogValueFormat3	##0.00	⚡
AnalogValueFormat4	0.5	⚡

6. Licensing

Each OS client that is used for viewing OPD requires a license. The license key is issued by PlantVision and is unique for each OS client.

In order to license an OS client, please follow these steps:

1. Send the host name of the OS client(s), that is going to be used for viewing the OPD, along with the PCS 7 version, to support@pcs7opd.com. Please, provide the license certificate number as well.
2. You will be provided with a license key for each OS client.
3. For each OS client create a tag: OPD_LICENSEKEY_<hostname> in the OS project that is going to be run on the specific OS client. If the same OS project is going to be run on several OS clients, create a specific tag for each OS client in the same project.
4. Enter the license keys as Start values for the license tags.

The following tags have been created on a OS client project that is going to be used on 2 OS clients with host names: OSC1 and OSWEB.

Tags [OPD]			Find
	Name	Start value	S
1	OPD_CSV_PATH	C:\ProgramData\OPD\OPDconfig.csv	
2	OPD_ES_DOMAINS		
3	OPD_LANGUAGE	Swedish	
4	OPD_LANGUAGE_PATH	C:\ProgramData\OPD\OPDlanguage.csv	
5	OPD_LASTDOMAIN		
6	OPD_LICENSEKEY_OSC1	DxPB,LWL4x>=WBBD	
7	OPD_LICENSEKEY_OSWEB	E5PV@AQGIM9VxLFJ	
8	✖		
9			

6.1. Web server license

A Web navigator server requires a specific “Web license”. This specific web license is valid for all OS web clients.

In order to license a Web server, please follow these steps:

1. Send the host name of the Web server to support@pcs7opd.com. Please, provide the license certificate number as well.
2. You will be provided with a license key.
3. On the web server project, create a tag: OPD_LICENSEKEY_<hostname> (host name of the web server)
4. Enter the license key as Start value for the license tag.

7. Appendix

7.1. OPD Block Inputs/Outputs

The following is the list of all inputs and outputs on OPD block:

Name	IN/OUT	Type	Description
RstLi	IN	STRUCT	Linked reset signal
RstOp	IN	BOOL	Operator reset signal
MsgLock	IN	STRUCT	Inhibit process message
SampleTime	IN	REAL	Sampling time [s]
MsgEvid1	IN	DWORD	Message event ID
FaultExt	IN	STRUCT	External Error
CSF	IN	STRUCT	Control system fault message – External error
UserStatus	IN	BYTE	User status bits
OpSt_In	IN	DWORD	Enabled operator stations
OS_Perm	IN	STRUCT	Operator permissions
Feature	IN	STRUCT	Status of various features
Feature2	IN	STRUCT	Status of various features
BatchEn	IN	BOOL	Enable remote operation of controller by Batch recipe
BatchID	IN	DWORD	Current Batch ID (number)
BatchName	IN	STRING[32]	Current Batch name
StepNo	IN	DWORD	Batch step number
Occupied	IN	BOOL	Occupied by Batch
SelfDisable	IN	BOOL	Self disable
OPD_EN	IN	BOOL	Enable OPD
OP_EXE	IN	BOOL	Operator Execute
PV1_S	IN	STRING[32]	Text Process Value 1
PV1_R	IN	REAL	Analog Process Value 1
PV2_S	IN	STRING[32]	Text Process Value 2

Name	IN/OUT	Type	Description
PV2_R	IN	REAL	Analog Process Value 2
PV3_S	IN	STRING[32]	Text Process Value 3
PV3_R	IN	REAL	Analog Process Value 3
PV4_S	IN	STRING[32]	Text Process Value 4
PV4_R	IN	REAL	Analog Process Value 4
PV5_S	IN	STRING[32]	Text Process Value 5
PV5_R	IN	REAL	Analog Process Value 5
PV6_S	IN	STRING[32]	Text Process Value 6
PV6_R	IN	REAL	Analog Process Value 6
PV7_S	IN	STRING[32]	Text Process Value 7
PV7_R	IN	REAL	Analog Process Value 7
PV8_S	IN	STRING[32]	Text Process Value 8
PV8_R	IN	REAL	Analog Process Value 8
PV9_S	IN	STRING[32]	Text Process Value 9
PV9_R	IN	REAL	Analog Process Value 9
PV10_S	IN	STRING[32]	Text Process Value 10
PV10_R	IN	REAL	Analog Process Value 10
OPV1_L1	IN	REAL	Operator Value 1 Low Limit 1
OPV1_H1	IN	REAL	Operator Value 1 High Limit 1
OPV2_L1	IN	REAL	Operator Value 2 Low Limit 1
OPV2_H1	IN	REAL	Operator Value 2 High Limit 1
OPV3_L1	IN	REAL	Operator Value 3 Low Limit 1
OPV3_H1	IN	REAL	Operator Value 3 High Limit 1
OPV4_L1	IN	REAL	Operator Value 4 Low Limit 1
OPV4_H1	IN	REAL	Operator Value 4 High Limit 1
OPV5_L1	IN	REAL	Operator Value 5 Low Limit 1
OPV5_H1	IN	REAL	Operator Value 5 High Limit 1
OPV6_L1	IN	REAL	Operator Value 6 Low Limit 1
OPV6_H1	IN	REAL	Operator Value 6 High Limit 1
OPV7_L1	IN	REAL	Operator Value 7 Low Limit 1

Name	IN/OUT	Type	Description
OPV7_H1	IN	REAL	Operator Value 7 High Limit 1
OPV8_L1	IN	REAL	Operator Value 8 Low Limit 1
OPV8_H1	IN	REAL	Operator Value 8 High Limit 1
OPV9_L1	IN	REAL	Operator Value 9 Low Limit 1
OPV9_H1	IN	REAL	Operator Value 9 High Limit 1
OPV10_L1	IN	REAL	Operator Value 10 Low Limit 1
OPV10_H1	IN	REAL	Operator Value 10 High Limit 1
OPD_NR	IN	INT	OPD Message Number
HMI_TIME	IN	INT	HMI-Timer Time [sec]
WD_TIME	IN	INT	WatchDog-Timer Time [sec]
RST_OPV	IN	BOOL	Reset Operator Values
RST_ES1	IN	BOOL	Reset ES1
RST_ES2	IN	BOOL	Reset ES2
RST_TIM	IN	BOOL	Reset TIMER
OS_PermOut	OUT	DWORD	Operator permission: output for OS
OS_PermLog	OUT	DWORD	Operator permission: output for OS
OpSt_Out	OUT	DWORD	Enabled operator stations
ST_Worst	OUT	BYTE	Worst signal status
Status1	OUT	DWORD	Status1 word
Status2	OUT	DWORD	Status2 word
Status3	OUT	DWORD	Status3 word
QMSG1_ERR	OUT	BOOL	Error message output 1
MSG1_STAT	OUT	WORD	Message state 1 (OS)
MSG1_ACK	OUT	WORD	Message acknowledge 1 (OS)
QEN	OUT	BOOL	OPD Enabled
QEXECUTE	OUT	BOOL	OPD Executed
QOPD_NR	OUT	INT	OPD Message Number
QWD_TIMER	OUT	INT	Watch Dog-Timer [sec]
QWATCHDOG	OUT	BOOL	Watch Dog
QHMI_TIMER	OUT	INT	HMI-Timer [sec]

Name	IN/OUT	Type	Description
QHMI_CNAME	OUT	STRING[32]	OPD HMI Users Computer Name
QHMI_USER	OUT	STRING[32]	OPD HMI User Name
QHMI_ACT	OUT	BOOL	OPD HMI Activated, Locked by Current Computer
QHMI_DIS	OUT	BOOL	Disable HMI
QEXE_RDY	OUT	BOOL	OPD Ready for Execute
QEXE_EN	OUT	BOOL	Execute Enabled
QES_EN	OUT	BOOL	ES Enabled
QOBJ_EN	OUT	BOOL	Object Enabled
QBRIDGE	OUT	BOOL	Bridge values
QMSG_ERR	OUT	BOOL	Alarm8p ERROR
QMSG_STAT	OUT	WORD	Alarm8p STATUS
QMSG_ACK	OUT	WORD	Alarm8p ACK_STATE
QOPV1_R	OUT	REAL	Operator Analog Value 1
QOPV2_R	OUT	REAL	Operator Analog Value 2
QOPV3_R	OUT	REAL	Operator Analog Value 3
QOPV4_R	OUT	REAL	Operator Analog Value 4
QOPV5_R	OUT	REAL	Operator Analog Value 5
QOPV6_R	OUT	REAL	Operator Analog Value 6
QOPV7_R	OUT	REAL	Operator Analog Value 7
QOPV8_R	OUT	REAL	Operator Analog Value 8
QOPV9_R	OUT	REAL	Operator Analog Value 9
QOPV10_R	OUT	REAL	Operator Analog Value 10
QOPV1_S	OUT	STRING[32]	Operator Text Value 1
QOPV2_S	OUT	STRING[32]	Operator Text Value 2
QOPV3_S	OUT	STRING[32]	Operator Text Value 3
QOPV4_S	OUT	STRING[32]	Operator Text Value 4
QOPV5_S	OUT	STRING[32]	Operator Text Value 5
QOPV6_S	OUT	STRING[32]	Operator Text Value 6
QOPV7_S	OUT	STRING[32]	Operator Text Value 7
QOPV8_S	OUT	STRING[32]	Operator Text Value 8

Name	IN/OUT	Type	Description
QOPV9_S	OUT	STRING[32]	Operator Text Value 9
QOPV10_S	OUT	STRING[32]	Operator Text Value 10
QOPOSEL1	OUT	INT	Operator Option Box Button Selection 1
QOPCSEL1	OUT	WORD	Operator Check Box Selection 1
QES1_UNAME	OUT	STRING[32]	Electronic Signature 1, User Name
QES1_FNAME	OUT	STRING[50]	Electronic Signature 1, Full Name
QES1_DATE	OUT	STRING[20]	Electronic Signature 1, Date Time
QES1_CNAME	OUT	STRING[32]	Electronic Signature 1, Computer Name
QES2_UNAME	OUT	STRING[32]	Electronic Signature 2, User Name
QES2_FNAME	OUT	STRING[50]	Electronic Signature 2 Full Name
QES2_DATE	OUT	STRING[20]	Electronic Signature 2, Date Time
QES2_CNAME	OUT	STRING[32]	Electronic Signature 2, Computer Name

7.2. OS Server Tags

The following tags should be configured on the OS server (or OS single station) project:

Name	Data type	Length	Connection	Group	Start value
OPD_ES_CNAME	Text tag 16-bit character set	255	Internal tags	OPD	
OPD_ES_DOMAIN	Text tag 16-bit character set	255	Internal tags	OPD	
OPD_ES_DOMAINS	Text tag 16-bit character set	255	Internal tags	OPD	
OPD_ES_FULLNAME	Text tag 16-bit character set	255	Internal tags	OPD	
OPD_ES_GETDOMAINS	Binary Tag	1	Internal tags	OPD	
OPD_ES_PASSWORD	Text tag 16-bit character set	255	Internal tags	OPD	
OPD_ES_PICTURENAME	Text tag 8-bit character set	255	Internal tags	OPD	
OPD_ES_READY	Signed 32-bit value	4	Internal tags	OPD	999
OPD_ES_REQUIREDGROUPS	Text tag 16-bit character set	255	Internal tags	OPD	
OPD_ES_USERNAME	Text tag 16-bit character set	255	Internal tags	OPD	
OPD_ES_VERIFYUSER	Binary Tag	1	Internal tags	OPD	

7.3. OS Client Tags

The following tags should be configured on the OS client (or OS single station) project:

Name	Data type	Length	Connection	Group	Start value
OPD_CSV_PATH	Text tag 16-bit character set	255	Internal tags	OPD	C:\ProgramData\OPD\ OPDconfig.csv
OPD_ES_DOMAINS	Text tag 16-bit character set	255	Internal tags	OPD	
OPD_LANGUAGE	Text tag 16-bit character set	255	Internal tags	OPD	English
OPD_LANGUAGE_PATH	Text tag 16-bit character set	255	Internal tags	OPD	C:\ProgramData\OPD\OPDlanguage.csv
OPD_LASTDOMAIN	Text tag 16-bit character set	255	Internal tags	OPD	
OPD_LICENSEKEY_XYZ	Text tag 16-bit character set	255	Internal tags	OPD	...
OPD_LICENSEKEY_QWE	Text tag 16-bit character set	255	Internal tags	OPD	...

7.4. WinCC Messages

The following messages should be configured on the OS client (or OS single station) project:

Number	Message class	Message Type	Source	Area	Event	Batch name
100000	Status Message	Status OS	@8%s@	@7%s@	***** OPD ES BEGIN *****	@1%s@
100001	Status Message	Status OS	@8%s@	@7%s@	OPD Message Nr: @9%s@ executed by @10%s@	@1%s@
100010	Status Message	Status OS	@8%s@	@7%s@	OPD Message Part 1: @9%s@@10%s@	@1%s@
100011	Status Message	Status OS	@8%s@	@7%s@	OPD Message Part 2: @9%s@@10%s@	@1%s@
100020	Status Message	Status OS	@8%s@	@7%s@	OPD Process Value 1 @9%s@: @10%s@	@1%s@
100021	Status Message	Status OS	@8%s@	@7%s@	OPD Process Value 2 @9%s@: @10%s@	@1%s@
100022	Status Message	Status OS	@8%s@	@7%s@	OPD Process Value 3 @9%s@: @10%s@	@1%s@
100023	Status Message	Status OS	@8%s@	@7%s@	OPD Process Value 4 @9%s@: @10%s@	@1%s@
100024	Status Message	Status OS	@8%s@	@7%s@	OPD Process Value 5 @9%s@: @10%s@	@1%s@
100025	Status Message	Status OS	@8%s@	@7%s@	OPD Process Value 6 @9%s@: @10%s@	@1%s@
100026	Status Message	Status OS	@8%s@	@7%s@	OPD Process Value 7 @9%s@: @10%s@	@1%s@
100027	Status Message	Status OS	@8%s@	@7%s@	OPD Process Value 8 @9%s@: @10%s@	@1%s@
100028	Status Message	Status OS	@8%s@	@7%s@	OPD Process Value 9 @9%s@: @10%s@	@1%s@
100029	Status Message	Status OS	@8%s@	@7%s@	OPD Process Value 10 @9%s@: @10%s@	@1%s@
100030	Status Message	Status OS	@8%s@	@7%s@	OPD Operator Value 1 @9%s@: @10%s@	@1%s@
100032	Status Message	Status OS	@8%s@	@7%s@	OPD Operator Value 2 @9%s@: @10%s@	@1%s@
100034	Status Message	Status OS	@8%s@	@7%s@	OPD Operator Value 3 @9%s@: @10%s@	@1%s@
100036	Status Message	Status OS	@8%s@	@7%s@	OPD Operator Value 4 @9%s@: @10%s@	@1%s@
100038	Status Message	Status OS	@8%s@	@7%s@	OPD Operator Value 5 @9%s@: @10%s@	@1%s@
100040	Status Message	Status OS	@8%s@	@7%s@	OPD Operator Value 6 @9%s@: @10%s@	@1%s@
100042	Status Message	Status OS	@8%s@	@7%s@	OPD Operator Value 7 @9%s@: @10%s@	@1%s@
100044	Status Message	Status OS	@8%s@	@7%s@	OPD Operator Value 8 @9%s@: @10%s@	@1%s@
100046	Status Message	Status OS	@8%s@	@7%s@	OPD Operator Value 9 @9%s@: @10%s@	@1%s@
100048	Status Message	Status OS	@8%s@	@7%s@	OPD Operator Value 10 @9%s@: @10%s@	@1%s@
100050	Status Message	Status OS	@8%s@	@7%s@	OPD Option Box Group 1 @9%s@. Chosen Option: @10%s@	@1%s@
100060	Status Message	Status OS	@8%s@	@7%s@	OPD Check Box Group 1 @9%s@ Chosen Options: @10%s@	@1%s@

100070	Status Message	Status OS	@8%s@	@7%s@	OPD Electronic Signature 1 @9%s@ on @10%s@	@1%s@
100072	Status Message	Status OS	@8%s@	@7%s@	OPD Electronic Signature 2 @9%s@ on @10%s@	@1%s@
100080	Status Message	Status OS	@8%s@	@7%s@	OPD Comment Part 1: @9%s@@10%s@	@1%s@
100081	Status Message	Status OS	@8%s@	@7%s@	OPD Comment Part 2: @9%s@@10%s@	@1%s@
100100	Status Message	Status OS	@8%s@	@7%s@	***** OPD ES END *****	@1%s@

7.5. Scripts

The following is the list of all scripts used by the OPD:

Name	Type
OPDAllocateBlock	C-script
OPDAuditTrail	C-script
OPDBridgeValues	C-script
OPDCalculateHeight	C-script
OPDCheckIfEnabled	C-script
OPDCheckIfExecuted	C-script
OPDCheckIfOpened	C-script
OPDConvertFormat	C-script
OPDCountCSVLines	C-script
OPDCreateMsg	C-script
OPDDecrypt	C-script
OPDGetCSVFieldChar	C-script
OPDGetCSVFieldInt	C-script
OPDInvokeSignature	C-script
OPDOnChecks	C-script
OPDOnOK	C-script
OPDOnOptions	C-script
OPDOpenPicture	C-script
OPDReadCSV	C-script
OPDReadLanguage	C-script
OPDReadLine	C-script
OPDReadOPDnumber	C-script
OPDReadUA	C-script
OPDResetES	C-script
OPDUpdateRequired	C-script
OPD_GetDomains	VB-script
OPD_OnES	VB-script

Name	Type
OPD_SetESWEB	VB-script
OPD_VerifyUser	VB-script
OPD_VerifyUserWEB	VB-script
OPD_ReadVersion	VB-script

7.6. Actions

The following is the list of all actions used by the OPD:

Name	Type
OPD_GetDomainsAction	VB-script
OPD_VerifyUserAction	VB-script